

296.346

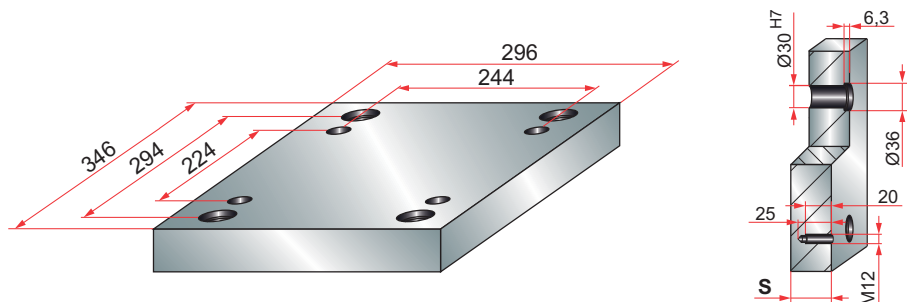

PBA

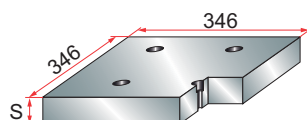

	PBA
S	27
	36
mat.: 1.1730	

PBA-EU

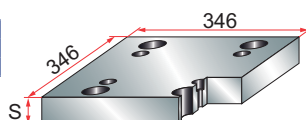

	PBA-EU
S	27
	36
mat.: 1.1730	

PBAV

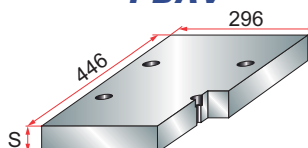

	PBAV
S	27
	36
mat.: 1.1730	

PBAV-EU

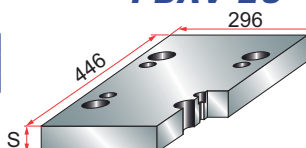

	PBAV-EU
S	27
	36
mat.: 1.1730	

PBAS

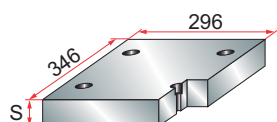

	PBAS
S	27
	36
	46
mat.: 1.1730	

PBAS-EU

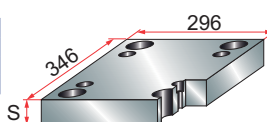

	PBAS-EU
S	27
	36
	46
mat.: 1.1730	

PC

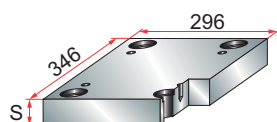

		Material			
		1.1730	1.2311	1.2312	1.2085
S	27	*	*	*	o
	36	*	*	*	o
	46	*	*	*	o
	56	*	*	*	o
	66	*	*	*	o
	76	*	*	*	o
	86	*	*	*	o
	96	*	*	*	o
	116	*	*	*	o
	136	*	*	*	o
	156	*	*	*	o

* Entrega 3/4 días - Delivery 3/4 days

PCX

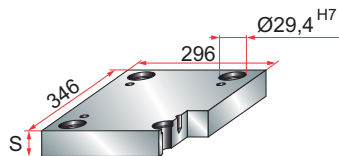

		Material			
		1.2311	1.2312	1.2344	1.2085
S	27	*	*	*	o
	36	*	*	*	o
	46	*	*	*	o
	56	*	*	*	o
	66	*	*	*	o
	76	*	*	*	o
	86	*	*	*	o
	96	*	*	*	o
	116	*	*	*	o
	136	*	*	*	o
	156	*	*	*	o

* Entrega 3/4 días - Delivery 3/4 days

296.346

PS

PS	
S	27
	36
	46

mat.: 1.1730

PS-EU

PS-EU	
S	27
	36
	46

mat.: 1.1730

ESP

ESP	
S	56
	66
	76
	86
	96

mat.: 1.1730

ESP-EU

ESP-EU	
S	56
	66
	76
	86
	96

mat.: 1.1730

CPE

mat.: 1.1730
mat.: 1.2311

P PLATES

PBA-P

PBA-P	
S	27
	36

mat.: 1.1730

PBAV-P

PBAV-P	
S	27
	36

mat.: 1.1730

PC-P

S	Material			
	1.1730	1.2311	1.2312	1.2085
27	*	*	*	o
36	*	*	*	o
46	*	*	*	o
56	*	*	*	o
66	*	*	*	o
76	*	*	*	o
86	*	*	*	o
96	*	*	*	o
116	*	*	*	o
136	*	*	*	o
156	*	*	*	o

* Entrega 3/4 dias - Delivery 3/4 days

ESP-P

ESP-P	
S	56
	66
	76
	86
	96

mat.: 1.1730

PS-P

PS-P	
S	27
	36
	46

mat.: 1.1730

CPE-P

mat.: 1.1730
mat.: 1.2311