

PBA

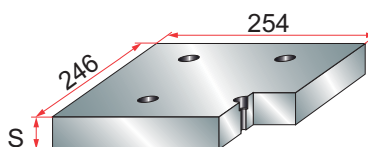

PBA	
S	22
	27

mat.: 1.1730

PBA-EU

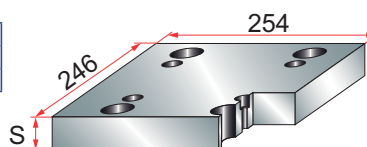

PBA-EU	
S	22
	27

mat.: 1.1730

PBAV

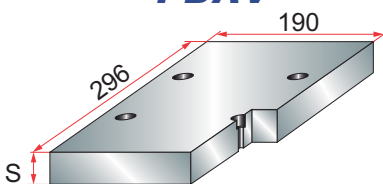

PBAV	
S	22
	27

mat.: 1.1730

PBAV-EU

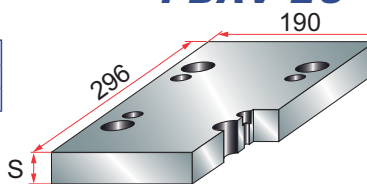

PBAV-EU	
S	22
	27

mat.: 1.1730

PBAS

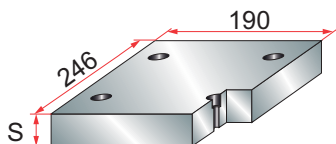

PBAS	
S	22
	27

mat.: 1.1730

PBAS-EU

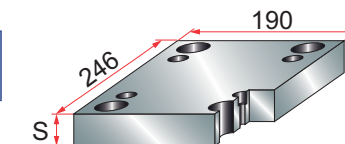

PBAS-EU	
S	22
	27

mat.: 1.1730

PC

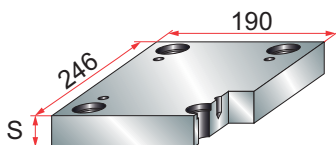

		Material			
		1.1730	1.2311	1.2312	1.2085
S	22	*	*	*	o
	27	*	*	*	o
	36	*	*	*	o
	46	*	*	*	o
	56	*	*	*	o
	66	*	*	*	o
	76	*	*	*	o
	86	*	*	*	o
	96	*	*	*	o
	116	*	*	*	o
	136	*	*	*	o

° Entrega 3/4 dias - Delivery 3/4 days

PCX

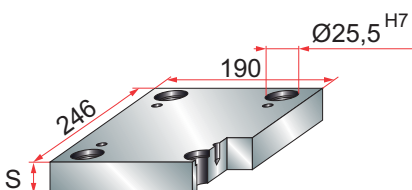

		Material			
		1.2311	1.2312	1.2344	1.2085
S	22	*	*	*	o
	27	*	*	*	o
	36	*	*	*	o
	46	*	*	*	o
	56	*	*	*	o
	66	*	*	*	o
	76	*	*	*	o
	86	*	*	*	o
	96	*	*	*	o
	116	*	*	*	o
	136	*	*	*	o

° Entrega 3/4 dias - Delivery 3/4 days

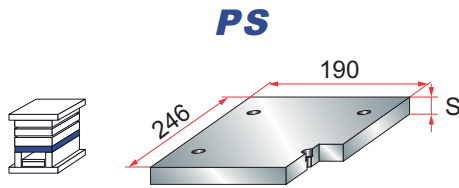

PS	
S	22
	27
	36

mat.: 1.1730

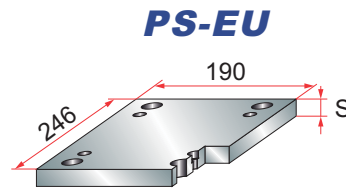

PS-EU	
S	22
	27
	36

mat.: 1.1730

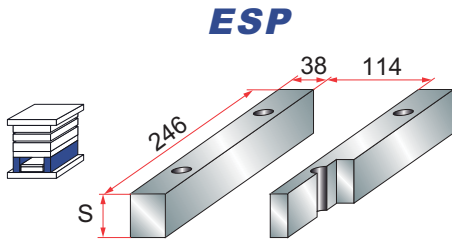

ESP	
S	46
	56
	66
	76

mat.: 1.1730

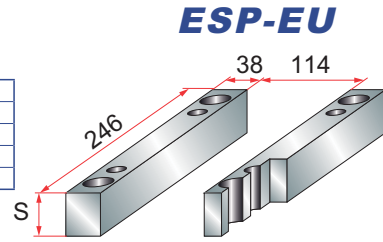

ESP-EU	
S	46
	56
	66
	76

mat.: 1.1730

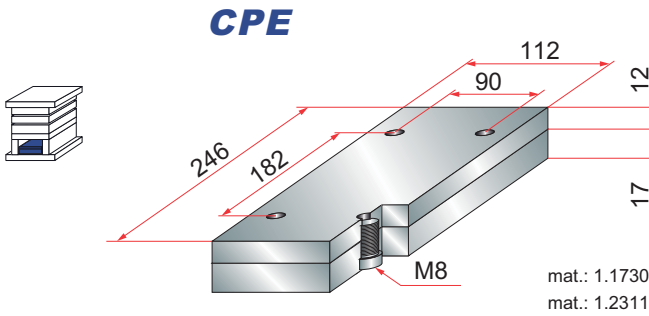

P PLATES

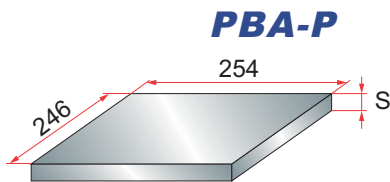

PBA-P	
S	22
	27

mat.: 1.1730

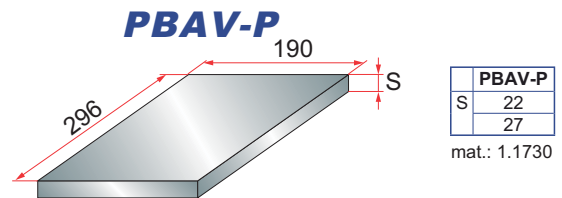

PBAV-P	
S	22
	27

mat.: 1.1730

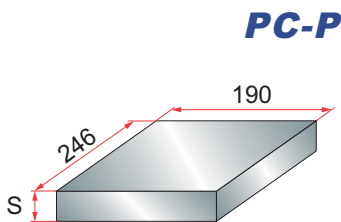

S	Material			
	1.1730	1.2311	1.2312	1.2085
22	*	*	*	o
36	*	*	*	o
46	*	*	*	o
56	*	*	*	o
66	*	*	*	o
76	*	*	*	o
86	*	*	*	o
96	*	*	*	o
116	*	*	*	o
136	*	*	*	o

° Entrega 3/4 días - Delivery 3/4 days

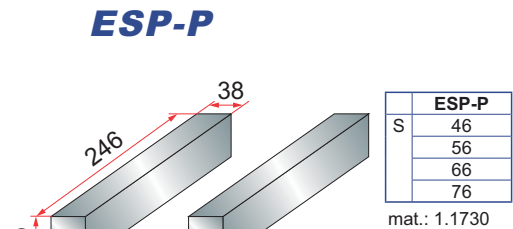

ESP-P	
S	46
	56
	66
	76

mat.: 1.1730

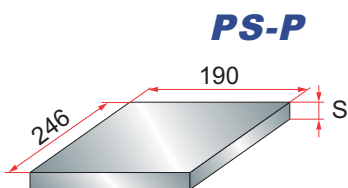

PS-P	
S	22
	27
	36

mat.: 1.1730

